

CONTACT US



40 MAGNETIC DRIVE #48
TORONTO, ON, CANADA M3J 2C4

1 (800) 650-0930
WWW.FUJISPRAY.COM



CATALOGUE





ABOUT US

We are manufacturers of high-quality spray equipment that delivers a perfect finish every time. We have been in operation for over 30 years and our versatile spray systems meet the needs of both industry professionals and DIY-ers globally. As leaders in the HVLP industry, Fuji Spray® services a wide range of finishing industries including: woodworking, automotive, marine, bath tub re-glazing, paint, as well as confectionary and spray tanning.

Our spray systems offer the most environmentally-friendly solutions – HVLP is clean technology! We hold patents for our innovative designs, for both our turbines and spray guns. Our products are designed and made in Canada, and we stand by our products with a world-class, technical support team.

Our goal is to offer products of exceptional quality with trusted service.

Mark Rosin

President

EXCLUSIVE TO FUJI SPRAY®

→ SIDE-MOUNTED FAN PATTERN CONTROL™ (PATENTED)



Fuji Spray® offers three different spray gun models featuring a Side-Mounted Fan Pattern Control™ to adjust the size of the fan (T70™, T75G™ and G-XPC™).

This control allows the operator to switch from a circular to oval pattern and anywhere in between. Unlike traditional HVLP turbine spray guns with the front collar adjustment, the Side-Mounted Fan Pattern Control™ offers full incremental fan size throughout the whole range. Located on the left side of the spray gun for convenience, it is easy to adjust: turn counter-clockwise for a smaller pattern and clockwise for larger.

→ NOISE-REDUCTION TECHNOLOGY (PATENTED)

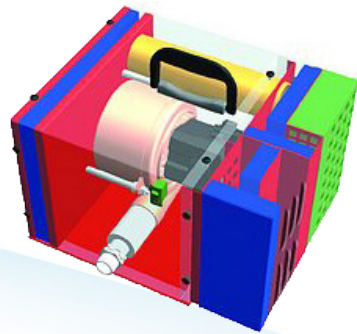

One of the most desirable features for any turbine is to have it operate as quiet as possible. A standard turbine sounds like a loud vacuum cleaner. Many woodworkers use ear protection, but if you have a smaller shop with neighbours (or have employees working in the same area), we recommend choosing a model from the Q PLATINUM™ Series.

Fuji Spray® has reduced turbine noise levels by over 50% without causing any unwanted challenges, such as overheating through air restriction. Fuji Spray® does not surround the turbine motor with soundproofing material, but rather uses a method that allows the turbine motor to sit in an all-metal enclosure the way that standard turbines do. The Fuji Spray® Q Series turbines have computer-designed airflow configurations that completely eliminate 'direct sound paths' found on low- to mid-priced HVLP turbine systems available today. These direct sound paths, or DSP's, are responsible for the

noise. In fact, when the Fuji Spray® Q Series turbine is placed across the room, the low hiss of air passing through the spray gun when the trigger is engaged is more noticeable than the turbine. Fuji Spray® Q PLATINUM™ Series turbines are protected by US Patent No.6644913.

At 15ft, the Q3 PLATINUM™ Turbine is only 62 dba, and at 20ft, it is 58 dba.

At 15ft, the Q4 PLATINUM™ Turbine is only 61 dba, and at 20ft it is 59 dba.

At 15ft, the Q5 PLATINUM™ Turbine is only 63 dba, and at 20ft it is 60 dba.

Compare this to a standard turbine at 79 dba from 15ft and 77 dba from 20ft. A normal conversation is rated at 60 dba. The Q PLATINUM™ Series turbines are the quietest operating HVLP turbines on the market today.

→ HEAT DISSIPATION CHAMBER™

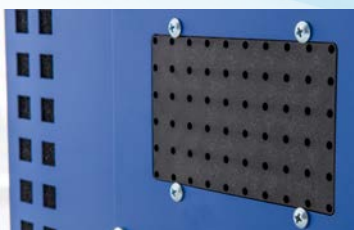

The Mini-Mite PLATINUM™ and Q PLATINUM™ turbines feature the proprietary Heat Dissipation Chamber™. This chamber expels excess heat from the turbine resulting in cooler operating temperatures. Less heat translates to increased motor longevity since the hot air is routed to the rear, passing through 60 vents – the process is silent.



Q PLATINUM™ SERIES

The ultimate system for the professional refinisher, the Q PLATINUM™ Series delivers: power, speed and versatility while continuing to be the quietest HVLP spray system on the market.



The Fuji Spray® Q PLATINUM™ series is for those who simply want the best all around spray experience. The ultimate finishing tool in terms of power and control allowing you to focus on what really matters – the quality of your work. The patented noise reduction technology coupled with the unique Heat Dissipation Chamber™ makes the Q-series a stand out in the industry.

The Q PLATINUM™ series are available in 3, 4 or 5-stage turbines making it perfect for fine-finishing of cabinets, furniture, as well as medium to heavy painting projects.

EXCLUSIVE TO FUJI SPRAY®

→ THE FUJI SPRAY® HEAT DISSIPATION CHAMBER™



Fuji Spray® has designed a unique method of removing any heat build up from the turbine case. Excess heat is channeled to a Heat Dissipation Chamber™ located at the rear of the case.

Since the hot air is dissipated evenly through an optimum surface area of 60 holes, there is no added hiss or loud whistling noise. There is also no blowing around of debris.

The benefits of a cooler running unit results in a longer life for your turbine motor compared to standard turbines.

→ NOISE REDUCTION TECHNOLOGY

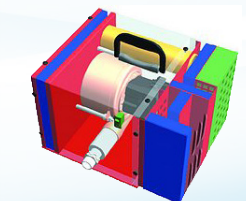

The most desirable feature for any turbine is to have it as quiet as possible. The Fuji Spray® noise reduction method is patented in the USA.

Fuji Spray® was able to reduce turbine noise levels by over 50% without causing any unwanted side effects such as overheating or air restriction.

The patented Noise Reduction Technology designed by Fuji Spray® has an exclusive, computer-designed airflow configuration which eliminates the "direct sound paths", found on low to mid-priced HVLP turbine systems available today. Direct sound paths are responsible for the noise factor. The Q PLATINUM™ Series reduces noise to less than 50% compared to previous levels. In fact, when the Q PLATINUM™ turbine is placed across the room, the low hiss of air passing through the spray gun is more noticeable than the turbine motor itself. We have the quietest spray system on the market!

Q PLATINUM™ SERIES



SYSTEMS

KEY FEATURES:

- U.S. patented noise reduction technology - reducing motor operation decibel levels by 50%
- Non-bleed turbine spray gun - choice of 3 different HVLP turbine spray guns (T70™, T75G™, G-XPC™)
- U.S. Patented Fan Pattern Control™ - unique to Fuji Spray®
- Cup capacity ranging from 3oz (89cc) to 1Qt (1000cc)
- Stainless steel needle, nozzle, and fluid passages
- High transfer efficiency - ensures whichever coating/material being sprayed is applied with the finest atomization, quickly and efficiently
- Heat Dissipation Chamber™ - dissipates heat resulting in increased turbine motor life
- Variable Speed Dial (Q5 system) - controls motor speed, allows the operator to make adjustments to the pressure output based on the coating being sprayed
- PSI ranging from 6.5 to 9.5
- Rugged metal turbine case
- Quick-change friction fit filter

WHAT MAKES THIS SERIES DIFFERENT:

- "Q" is for quiet - the quietest operating turbine on the market
- Powerful and versatile - regardless of the motor stage
- Convenient fan pattern adjustment at your finger tips
- Three fan pattern orientations horizontal, vertical, and circle
- Multiple air cap sizes allow for spraying of various materials in different viscosity levels from stains to paints with little or no dilution
- Can be used with a range of materials (high to low viscosity)
- Suitable for waterborne and solvent-based coatings
- Easy to disassemble spray gun resulting in hassle-free clean up and maintenance
- Handy gun-holder and a 25ft Hi-Flex™ hose - designed to give the operator more maneuverability
- 2-year warranty on parts and labor

EVERY FUJI SPRAY® Q PLATINUM™ SYSTEM CONTAINS

- Turbine
- Choice of Fuji Spray® gun (T70™, T75G™ or G-XPC™) with cup
- 25ft Hose with quick-connect and air control valve
- User manual
- Viscosity cup (#4 Ford)
- Wrench
- Cleaning brush

THE Q5 PLATINUM™ SYSTEM ALSO INCLUDES THE 5 FOR 5 BONUS KIT

- 6' Whip Hose
- 19pc Spray Gun Cleaning Kit
- Extra Turbine Filters
- Wet Film Gauge
- "Always Measure" Booklet



HIGHLIGHT OF Q5 PLATINUM™ SERIES

The Q5 PLATINUM™ Turbine with its powerful 5-stage motor produces approximately 9.5psi, allowing for less thinning of viscous materials and achieves finer atomization.

The Q5 features many new technological advancements. Incorporated into its design is a proprietary **Heat Dissipation Chamber™ (HDC)** as well as Fuji's patented noise reduction methodology.

Another key feature is the **Variable Speed Control Dial** that offers you the ability to adjust the out-put pressure to the optimum adjustment needed to perfectly atomize your coating. This is achieved by introducing the correct amount of air to the fluid stream reducing overspray/ bounce-back and dry spray to an absolute minimum.



MINI-MITE PLATINUM™ SERIES

If you're a professional woodworker or cabinetmaker on-the-go looking for a spray system with enough power and portability for your fine-finishing projects, the award-winning Fuji Spray® Mini-Mite PLATINUM™ series is a must for your business. The Mini-Mite PLATINUM™ series can handle any type of coating, allowing you to spray cabinets, furniture, autos or pianos.



Available in 3, 4, or 5-stage turbines giving you enough power to achieve a flawless finish every time.

→ EXCLUSIVE TO FUJI SPRAY® - THE FUJI SPRAY® HEAT DISSIPATION CHAMBER™



Fuji Spray® has designed a unique method of removing any heat build up from the turbine case. Excess heat is channeled to a Heat Dissipation Chamber™ located at the rear of the case.

Since the hot air is dissipated evenly through an optimum surface area of 60 holes, there is no added hiss or loud whistling noise. There is also no blowing around of debris.

The benefits of a cooler running unit results in a longer life for your turbine motor compared to standard turbines.

KEY FEATURES:

- Non-bleed turbine spray gun – choice of 3 different HVLP turbine spray guns (T70™, T75G™, G-XPC™)
- U.S. Patented Fan Pattern Control™ – unique to Fuji Spray®
- Cup capacity ranging from 3oz (89cc) to 1Qt (1000cc)
- Stainless steel needle, nozzle, and fluid passages
- Heat Dissipation Chamber™ – dissipates heat resulting in increased turbine motor life
- Noise Reduction Covers™ – muffles the operating level by removing direct sound paths
- PSI ranging from 6.5 to 9.5
- Rugged metal turbine case
- Quick-change friction fit filters
- High transfer efficiency – ensures whichever coating/material being sprayed is applied with the finest atomization, quickly and efficiently

MINI-MITE PLATINUM™ SERIES

WHAT MAKES THIS SERIES DIFFERENT:

- Lightweight and portable
- Powerful and versatile – regardless of the motor stage
- Simple fan pattern adjustment from circular to wide at your fingertips
- Three fan pattern orientations – horizontal, vertical, and circle
- Multiple air cap sizes allow for spraying of various materials in different viscosity levels from stains to paints with little or no dilution
- Disassembles easily for quick clean-up and maintenance
- A quieter overall spray experience compared to previous models
- Suitable for both waterborne and solvent-based coatings
- Easy to disassemble spray gun makes for hassle-free clean up and maintenance
- 2-year warranty on parts and labor



SYSTEMS

EVERY FUJI SPRAY® MINI-MITE PLATINUM™ SYSTEM CONTAINS

- Turbine
- Choice of Fuji Spray® gun (T70™, T75G™ or G-XPC™) with cup
- 25ft Hose with quick-connect and air control valve
- User manual
- Viscosity cup (#4 Ford)
- Wrench
- Cleaning brush



THE MINI-MITE 5 PLATINUM™ SYSTEM ALSO INCLUDES THE 5 FOR 5 BONUS KIT

- 6' Whip Hose
- 19pc Spray Gun Cleaning Kit
- Extra Turbine Filters
- Wet Film Gauge
- "Always Measure" Booklet



The Mini-Mite 3 PLATINUM™ System voted **Authors Best Overall and Best Value** in Fine Woodworking Magazine and awarded Top Honors in the March 2017 **WOOD Magazine review**, with **Top Tool** and **Top Value**.

The Mini-Mite 5 PLATINUM™ System voted **Power Tool of the Year** in Canadian Woodworking Magazine.

DIY-PRO™ SERIES



Whether you're a weekend warrior or a "serious" hobbyist, the DIY-PRO™ series offers you the perfect combination of flexibility and performance to get the job done. Considered the 'go-to' system for both shop and home use, the DIY-PRO™ series is ideal for spraying walls, ceilings, doors, fences, shutters, cabinets, and so much more! The DIY-PRO™ series will allow you to obtain an outstanding finish, making you look like a professional.



Most HVLP systems typically feature low wattage motors that are underpowered for spraying higher viscosity finishes. Our 1400 watt 2-stage bypass motor in a metal turbine casing can handle almost any type of coating.

KEY FEATURES:

- M-Model™ non-bleed spray gun
- 400cc gravity or 1Qt (1000cc) bottom feed cup capacity
- Convertible spray gun from bottom to gravity and vice-versa
- Additional air cap sizes available: .8mm - 2.0mm
- Stainless steel nozzle & needle
- Dedicated fan pattern control
- Powerful 1400 watt 2-Stage Motor
- 25ft Hi-Flex™ hose
- Rugged metal turbine case
- Handy gun-holder
- Quick-change filters

WHAT MAKES THIS SERIES DIFFERENT:

- Entry level system offering professional grade results
- Budget friendly
- Sleek spray gun design that can be converted from a bottom feed cup to a gravity feed cup and vice versa
- Multiple air cap sizes allow for spraying of various materials in different viscosity levels from stains to paints with little or no dilution
- Easily adjust the fan pattern from wide to narrow
- Faster application than a roller or brush
- Save money on finish - low overspray = less material used
- Easy to disassemble spray gun makes for hassle-free clean up and maintenance
- Lightweight and portable
- Housed in a durable, metal case - is a powerful motor that delivers the best value on the market
- 2-year warranty on parts and labor

COMPARISON CHART

Components	MODEL		
	Q3 PLATINUM™	Q4 PLATINUM™	Q5 PLATINUM™
Spray Gun *T70™ **T75G™ ***G-XPC™	✓	✓	✓
Cup Capacity *1 Quart (1000cc) **600cc Nylon I ***400cc Aluminum	✓	✓	✓
Air Cap	1.3mm	1.3mm	1.4mm
Air Filters Single #5029	✓	✓	✓
Hi-Flex™ Hose 25ft (7.6m)	✓	✓	✓
Motor Type	3-Stage	4-Stage	5-Stage
Heat Dissipation Chamber™	✓	✓	✓
Turbine Dimensions 14.87" x 11.5" x 9"	✓	✓	✓
Turbine Weight	22.29lbs/lbs	22.73lbs	24.06lbs
Voltage -Hz 110-120 volts - 60Hz 220-240 volts - 50Hz	✓	✓	✓
Amps	12 (110-120) 6 (220-240)	13 (110-120) 6.5 (220-240)	14.5 (110-120) 7.25 (220-240)
PSI	6.5	9	9.5
Bonus 5 for 5	N/A	N/A	✓
Warranty 24 Months - Parts & Labor	✓	✓	✓

* The T70™ comes standard with the quart (1000cc) cup capacity and 1.3mm air cap.
 ** The T75G™ comes standard with the 600cc nylon cup capacity and 1.3mm air cap.
 *** The G-XPC™ comes standard with the 400cc aluminum cup capacity and 1.4mm air cap.



Components	MODEL		
	Mini-Mite 3 PLATINUM™	Mini-Mite 4 PLATINUM™	Mini-Mite 5 PLATINUM™
Spray Gun *T70™ **T75G™ ***G-XPC™	✓	✓	✓
Cup Capacity *1 Quart (1000cc) **600cc Nylon I ***400cc Aluminum	✓	✓	✓
Air Cap	1.3mm	1.3mm	1.4mm
Air Filters PLATINUM™ Dual #7224-2	✓	✓	✓
Hi-Flex™ Hose 25ft (7.6m)	✓	✓	✓
Motor Type	3-Stage	4-Stage	5-Stage
Heat Dissipation Chamber™	✓	✓	✓
Turbine Dimensions 12" x 8.6" x 8.1"	✓	✓	✓
Turbine Weight	14.56lbs	15.00lbs	15.22lbs
Voltage -Hz 110-120 volts - 60Hz 220-240 volts - 50Hz	✓	✓	✓
Amps	12 (110-120) 6 (220-240)	13 (110-120) 6.5 (220-240)	14.5 (110-120) 7.25 (220-240)
PSI	6.5	9	9.5
Bonus 5 for 5	N/A	N/A	Yes
Warranty 24 Months - Parts & Labor	✓	✓	✓

* The T70™ comes standard with the quart (1000cc) cup capacity and 1.3mm air cap.
 ** The T75G™ comes standard with the 600cc nylon cup capacity and 1.3mm air cap.
 *** The G-XPC™ comes standard with the 400cc aluminum cup capacity and 1.4mm air cap.

COMPARISON CHART

WHICH SYSTEM IS BEST FOR YOU?

Components	MODEL		
	Semi-PRO 2™ Bottom Feed	Semi-PRO 2™ Gravity	Hobby-PRO 2™
Spray Gun M-Model™	✓	✓	✓
Cup Capacity	1 Quart (1000cc)	400cc (Aluminum)	1 Quart (1000cc)
Air Cap	1.3mm	1.3mm	1.8mm
Air Filters Dual #4009-2	✓	✓	✓
Hi-Flex™ Hose 25ft (7.6m)	✓	✓	✓
Motor Type 2-Stage	✓	✓	✓
Turbine Dimensions 11" x 8.6" x 8.1"	✓	✓	✓
Turbine Weight 12.35lbs	✓	✓	✓
Voltage -Hz 110-120 volts - 60Hz 220-240 volts - 50Hz	✓	✓	✓
Amps 11.5 (110-120) 5.75 (220-240)	✓	✓	✓
PSI 5	✓	✓	✓
Warranty 24 Months - Parts & Labor	✓	✓	✓

<p>DIY-PRO™ Series</p> 	<p>Budget-Friendly</p> <ul style="list-style-type: none"> 2-stage - 1400-watt motor with 25ft HI-Flex™ hose Perfect for weekender, DIYer, hobbyist - small to medium jobs Ideal for waterborne & solvent-based coatings Fan Pattern Control at the rear of the spray gun for easy accessibility M-Model™ spray gun (Gravity or Bottom Feed) disassembles easily for quick clean-up
<p>Mini-Mite PLATINUM™ Series</p> 	<p>Portable, lightweight and powerful</p> <ul style="list-style-type: none"> Perfect for those in the refinishing industry and "on the go"- bath-tub and woodworking Available in a 3, 4 or 5-stage turbine Ideal for a variety of coatings including varnishes, stains and automotive body-work coatings Noise Reduction Covers™ buffer the sound of the motor, making for a quieter experience overall
<p>Q PLATINUM™ Series</p> 	<p>Q = Quiet</p> <ul style="list-style-type: none"> Designed with Noise Reduction Technology (Patented) - Quietest turbine on the market Perfect for those in the refinishing industry Available in a 3, 4 or 5-stage turbine Medium to heavy-duty jobs Ideal for a variety of coatings including varnishes, stains and automotive body-work coatings Variable speed-control dial allows control over motor speed, to adjust atomization of the coating based on the project (Q5 only)

Mini-Mite PLATINUM™ and Q PLATINUM™ Series Shared Benefits

- Heat Dissipation Chamber™ eliminates heat build-up and keeps the turbine running cooler, extending the life of the motor
- Non-bleed spray gun - designed to stop the continuous flow of air when not in use, creating less mess and prevents damage to finished jobs
- Option of three different spray guns - (T70™, T75G™ or G-XPC™)
- G-XPC™ - Side-mounted 400cc gravity cup and the tilt feature which easily allows the operator to spray in any direction including upwards
- Spray gun has a Side-Mounted Fan Pattern Control™ (Patented) at your fingertips to adjustment fan spray from circular to wide

	DIY-PRO™ Series		Mini-Mite PLATINUM™ Series			Q PLATINUM™ Series		
Motor Type	2-Stage		3-Stage, 4-Stage & 5-Stage			3-Stage, 4-Stage & 5-Stage		
Spray Gun	M-Model™		T70™	T75G™	G-XPC™	T70™	T75G™	G-XPC™
Cup Capacity	1 Quart (1000cc)	400cc Aluminum	1 Quart (1000cc)	600cc Nylon	400cc Aluminum	1 Quart (1000cc)	600cc Nylon	400cc Aluminum
Heat Dissipation Chamber™	N/A		YES			YES		
Noise Reduction Technology	N/A		N/A			YES		
5 for 5 Bonus Kit	N/A		Mini-Mite 5 PLATINUM™			Q5 PLATINUM™		
Turbine Weight	14.4 LBS		16-24 LBS			23-26 LBS		
PSI	5		6.5-9.5			6.5-9.5		
Suggested Use	Light		Medium to Heavy			Medium to Heavy		



TURBINE SPRAY GUNS

TURBINE SPRAY GUN

Virtually all Fuji Spray® HVLP spray guns are non-bleed, meaning that air passes through the spray gun only when the trigger is engaged. All newer Fuji turbines are designed and built with a bleed-off inside the turbine to allow for use with any non-bleed spray gun.

The benefits of a non-bleed spray gun include:

- Less disturbance of shop dust and negligible turbulence in the spray area.
- Less paint buildup on the tip of the fluid nozzle.
- Spray gun noise (hiss of air) appears to be lessened, because now the hiss of air is intermittent.



T-MODEL™ TURBINE SPRAY GUN (PATENTED) T70™ & T75G™

The T-Model™ HVLP turbine spray gun was designed to meet the rising demand for a spray gun that offers the ultimate in flexibility and control.

The T-Model™ uses Canadian technology to deliver an enhanced spray pattern for exceptional performance. Combined with a new sleek design that is ergonomic and well balanced. Overall, the T-Model™ is 20% lighter than previous models which allows for easy maneuvering and decreased user fatigue. The Fuji Spray® T-Model™ spray gun also features an exclusive side-mounted Fan Pattern Control™ to adjust the size of the fan. This control allows you to switch fan patterns by simply turning the knob counter-clockwise for a circular pattern and clockwise for larger oval pattern. This method provides full incremental adjustment of the fan size.



With all these exceptional components the Fuji Spray® T-Model™ is a leader in the market, allowing users to achieve flawless performance and remarkable outcome every time. The T-Model™ is an excellent choice for professional use or for the serious hobbyist.

KEY FEATURES

- 1.3mm air cap set installed
- Rear rotating nipple for pressure tubes - makes for easier adjustment especially for those who are left handed
- Stay Cool Handle™ nylon-coated handle always stays cool and provides a comfortable grip
- Disassembles easily for quick clean-up and maintenance
- Metal fluid knob and collar
- Less blowing around of shop dust and negligible turbulence in the spray area

	T-MODEL™ SPRAY GUNS	
SPRAY GUN	T70™	T75G™
CUP CAPACITY	1 Quart (1000cc)	600cc Nylon
FEATURE	Center-mounted cup	
FAN PATTERN CONTROL	Side-mounted (Patented)	

- T-70™ (Bottom feed -1Qt. Cup) great for large jobs with less time spent on refilling the cup
- T75G™ (Gravity feed - 600cc) with center-mounted gravity cup is great for horizontal substrates, shading/touch up work and great for automotive refinishers
- Multiple air cap sizes allow for spraying of various materials in different viscosity levels from stains to paints with little or no dilution
- Stainless-steel fluid passages - Ideal for waterborne & solvent-based coatings
- Swivel/tilt cup feature - allows the user to spray at any angle easily

G-XPC™ GRAVITY (9600 G-XPC™)



	G-XPC™ GRAVITY SPRAY GUN
SPRAY GUN	G-XPC™
CUP CAPACITY	400cc Aluminum
FEATURE	Swivel/tilt
FAN PATTERN CONTROL	Side-mounted

This model features the 400cc side-mounted gravity cup with tilt feature, allowing the operator to easily spray in any direction including upwards. The G-XPC™ gravity spray gun comes installed with a high efficiency 1.4mm air cap set, which is best for fine finishing with lacquers, polyurethanes, latex, and water-based coatings. It also features a side-mounted Fan Pattern Control™ to adjust the fan size. The G-XPC™ is especially popular with bathtub refinishers and perfect for cabinets/furniture and automotive.

Optional cups are available in 3oz, 400cc, and 600cc (Nylon).

KEY FEATURES

- 1.4mm air cap set installed
- Swivel/tilt cup feature - allows the user to spray at any angle easily
- Side-Mounted Fan Pattern Control™
- Stay Cool Handle™ nylon-coated handle always stays cool and provides a comfortable grip
- Multiple air cap sizes allow for spraying of various materials in different viscosity levels from stains to paints with little or no dilution
- Stainless steel nozzle & needle - Ideal for waterborne & solvent-based coatings

M-MODEL™ (7001 M-MODEL & 7002G M-GRAVITY)

	M-MODEL™ SPRAY GUNS	
SPRAY GUN	7001 M-Model™	7002G M-Gravity™
CUP CAPACITY	1 Quart (1000cc)	400cc Aluminum
FEATURE	Convertible	
FAN PATTERN CONTROL	Located at rear	



A convertible spray gun that allows the user to work with a bottom feed or gravity feed cup, depending on the project. The versatile and ergonomic design takes the hassle out of any job! An ideal choice for the hobbyist or DIYer.

7001 M-MODEL™ SPRAY GUN

The 7001 M-Model™ is the spray gun of choice offered with all of our Semi-PRO™ 2 stage HVLP spray systems. This M-Model™ spray gun, with the 1 Qt. bottom feed cup is perfect for any hobbyist who needs to get the job done. Featuring a dedicated pattern control and 1.3mm air cap set installed.

KEY FEATURES

- Convertible, non-bleed, turbine spray gun - effortlessly converts from a bottom feed to a gravity feed gun and vice versa
- Disassembles easily for quick clean-up and maintenance
- Dedicated fan pattern control - allows for vertical, horizontal or circular applications, and can easily adjust from 1" circular to 12" oval pattern
- Available in bottom feed (1Qt.) or gravity (400cc) models
- Stay Cool Handle™ nylon-coated handle always stays cool and provides a comfortable grip
- Stainless steel nozzle & needle
- Additional air cap sizes available: .8mm - 2.0mm

NOTE: The parts for this M-Model™ spray gun are not compatible with other Fuji Spray® guns.

7002G M-MODEL™ SPRAY GUN

The 7002G M-Model™ is the gravity version of the 7001 M-Model™ and is offered with all of our Semi-PRO™ 2 gravity HVLP spray systems. The 7002G features a dedicated pattern control, a 400cc aluminum gravity cup attached via a U-Tube connection, and a 1.3mm air cap set installed.

9622 TOUCH-UP TURBINE BLEEDER SPRAY GUN



The Fuji Spray® Touch-Up turbine spray gun can be used with any HVLP turbine. Just attach with the quick connect coupler on your hose and begin spraying! Assembled with an 8oz mini cup, and 1.0mm air cap set. The #9622 features stainless steel fluid passages as well as needle and nozzle. The spray pattern can be adjusted from round ¼" to 6" spray pattern. Additional size 1.8 mm air cap set is available as an accessory.

This item is great for projects that require smaller touch-up work and is ideal for hard to reach places. A perfect addition to your Fuji Spray® HVLP System.

Please Note: This spray gun will not work with an air compressor.



WHICH HVLP SPRAY GUN IS BEST FOR YOU?

<p>M-Model™</p> 	<p>7001 M-Model™ & 7002G M-Model™ Gravity</p> <ul style="list-style-type: none"> • Convertible M-Model™ spray gun • Dedicated Fan Pattern Control - Allowing quick adjustment from circular to wide fan spray • 7001 M-Model (bottom feed - 1Qt. cup) - Ideal for the weekender or hobby enthusiast, great for bigger jobs. Won't require filling the cup as often. • 7002 M-Gravity (with 400cc cup) - Designed for the weekender or hobby enthusiast. The side mounted gravity cup allows greater versatility.
<p>T-Model™</p> 	<p>T-70™ & T75G™</p> <ul style="list-style-type: none"> • Sleek, ergonomic and well balanced. 20% lighter which allows for easy maneuvering and less fatigue on the operator • Offers ultimate flexibility and control • The only turbine spray gun on the market with a Side-Mounted Fan Pattern Control™ (Patented) • Obtain a professional finish with all types of coatings • An excellent choice for professional use or even for the serious hobbyist • Center mounted 600cc gravity cup or 1 Qt. bottom feed cup - resulting in less weight or pressure on the hand and wrist
<p>G-XPC™ Gravity</p> 	<p>9600 G-XPC™</p> <ul style="list-style-type: none"> • Side-mounted 400cc gravity cup with the tilt feature which easily allows the operator to spray in any direction including upwards • Side-mounted Fan Pattern Control - Allowing quick adjustment from circular to wide fan spray at your fingertips • Especially popular with bathtub refinishers but perfect for cabinets/furniture and automotive • Pressurized cup allowing the user a full variety of spraying techniques

Turbine Spray Guns - Shared Benefits

- Stay Cool Handle™ - nylon coated handle always stays cool even after long periods of spraying
- Non-bleed - reduces the blowing of shop dust and negligible turbulence in the spray area. Less paint build-up on the tip of the fluid nozzle
- Stainless-steel (interiors) fluid passages prevent wear on the needle and tip, resulting in the longevity of the air cap set and spray gun - Suitable for both waterborne & solvent-based coatings

	M-Model™ Spray Guns		T-Model™ Spray Guns		G-XPC™ Gravity Spray Gun
Spray Gun	7001 M-Model™	7002G M-Model™ Gravity	T70™	T75™	G-XPC™
Cup Capacity	1 Quart (1000cc)	400cc Aluminum	1 Quart (1000cc)	600cc Nylon	400cc Aluminum
Feature	Convertible		Center mounted		Swivel/tilt
Fan Pattern Control	Located at the back		Side-mounted		Side-mounted

TURBINE ACCESSORIES

AIR CAP SETS

High-efficiency air cap sets in multiple sizes to meet requirements of all different levels of viscosity and materials

If you own the T-Model™, please refer to the part numbers in your user manual (5100 series).

If you own the M-Model™, please refer to the part numbers in your user manual (7020 series).

If you own the G-XPC™/XPC™, please refer to the part numbers in your user manual (8050 series).

If you own an older XT or GT-X, please refer to the part numbers in your user manual (9001series).



#5137 CARRY CASE FOR AIR CAP SETS

Keep your air cap sets neatly in one place. The air cap set carry case can store 4 sets of needles, nozzles and air caps.

The T-Model™ (5100 series) and the M-Model™ (7020 series) will fit into this case.

Please note that the G-XPC™ (8050 series) and compressor spray gun air caps are not compatible with this case.

Case Only - air cap sets not included



#2049F 6FT WHIP HOSE

This lightweight 6ft. hose is highly flexible and features a smooth internal bore. Takes weight off the wrist and the flexibility allows for effortless maneuverability of the spray gun. Additional benefit is that the added distance from the turbine allows for cooler air to travel through the spray gun which is a bonus when working with fast-drying lacquers.

- 6ft flexible hose is also available in black #2268

Please note* this hose cannot be connected directly to the turbine - it is an extension hose and must only be connected to the end of the standard 25ft hose.



#7049 HI-FLEX™ 25FT HOSE:

The Fuji Hi-Flex™ 25ft hose includes a kink free spring to prevent bending and kinking at the turbine connection. Solid plastic hoses typical with most HVLP turbine systems are stiff making the spray gun difficult to maneuver. The Hi-Flex™ hose is not only flexible at different temperatures, it will stay flexible for years to come. This hose also includes a quick-connect coupling and air control valve.

- This hose is also available in black #9049



#7073 HVLP 30FT SUPER DUTY AIR HOSE:

This super duty air hose is 30 feet in length which includes 3ft of heat hose. It also includes a brass quick-connect and air-control valve.

Great performance and high quality.



#5432 2QT. PRESSURE POT ASSEMBLY KIT:

This 2Qt. Pressure Pot Assembly Kit has everything you need to add additional material capacity using your 4 or 5-stage Fuji Spray® HVLP system.

FEATURES:

- No need for bulky compressor. A 4 or 5-stage turbine is all you need
- Ability to spray at any angle, including upside down
- Twice as much material capacity than your bottom feed spray gun, and more than three times the capacity of your gravity feed spray gun
- Removes cup weight from the spray gun, reducing user fatigue

Please note: You will need both a standard 25ft hose plus a whip hose in order to use your Fuji Spray 2Qt. Pressure Pot.

Important: If you are using model 9600-C-XPC™ Spray Gun, you will also need a 9060 L-Fitting.



CUP PARTS KITS

Includes wearable parts that you should always have on hand.

- For 1 Qt. bottom feed cups - #2039

FOR GRAVITY CUPS REFER TO THE FOLLOWING GRAVITY CUPS PARTS KITS:

- 600cc Aluminum Gravity Cup - #2060
- 400cc Gravity Cup - #2030
- 600cc Nylon Cup - #2024L-5 (pressure tubes only)

A VARIETY OF CUPS AVAILABLE:

- #2041 1QT Aluminum Cup
- #2041T 1QT Aluminum Cup Teflon Coated
- #2042 1QT Aluminum Cup Assembly
- #2043T 1QT Aluminum Cup Teflon Coated Assembly



- #9730 3oz Gravity Cup Assembly – T-Model™
- #9740 400cc Gravity Cup Assembly – T-Model™
- #9760 600cc Aluminum Gravity Cup Assembly – T-Model™
- #9775 1000cc Gravity Cup Assembly – T-Model™
- #9080 250cc Mini Cup Assembly plus 2 extra cups
- #9850 400cc Gravity Cup Side Mounted - G-XPC™
- #9860 600cc Nylon Gravity Cup Assembly - T-Model™
- #9870 600cc Nylon Gravity Cup Assembly – G-XPC™



#9960 GRAVITY CUP CONVERSION KIT

This conversion kit allows any Fuji Spray® bottom feed gun to be converted to a gravity style. It includes a 400cc aluminum gravity cup, stainless steel U-tube, and pressure tube with check valve.



#9025-3 REUSABLE PAINT STRAINER (3 PACK)

Reusable cone type strainer. Coarse 70 micron mesh, for filtering most finishes.



#9070-40 CONE STRAINERS (40 PACK)

Remove unwanted particles, dust and impurities from your finishes.

Available in a 40 pack.

Prevents clogging of spray equipment.

For all types of stains, varnishes and paints.



#5262 REBUILD KIT FOR FUJI T70™/T75™ SPRAY GUNS

THIS REBUILD KIT INCLUDES:

- A collar
- Diffuser seal
- Air divider seal
- Air divider
- Needle packing
- Valve spring
- Needle spring
- Fluid adjusting knob

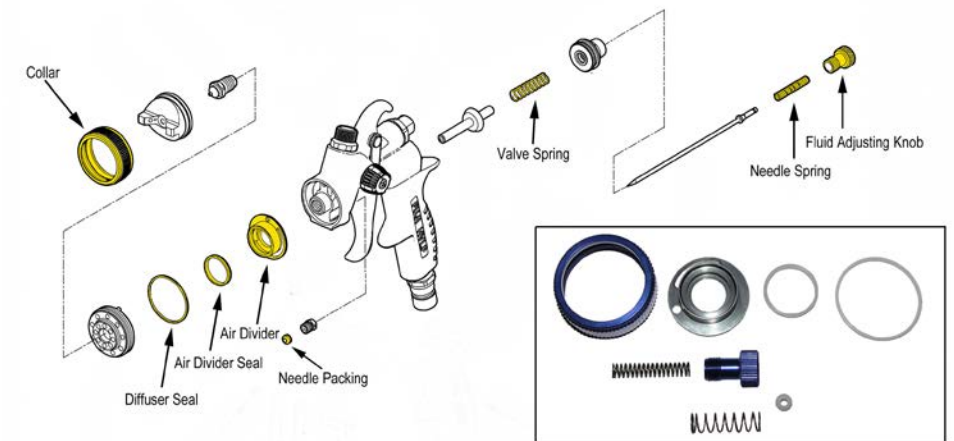

#9610 REBUILD KIT FOR FUJI G-XPC™/XPC™ SPRAY GUNS

THIS REBUILD KIT INCLUDES:

- A collar (blue)
- Needle packings (x2)
- Spindle valve spring
- Needle spring
- Fluid knob (blue)
- Needle packing nut
- Spindle valve seal (x6)
- Fluid screw nut seal

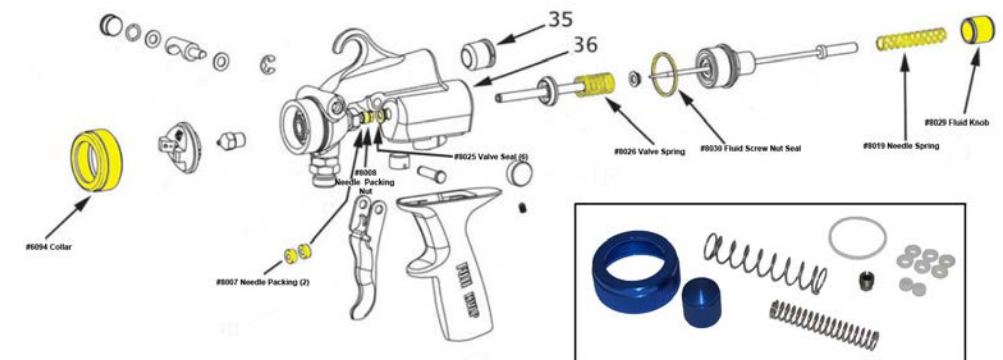

#5330 GRAVITY FEED GUN HOLDER STAND

This 2-piece gravity feed gun holder allows the user to strain and fill a gravity feed spray gun without assistance. You can also rest your Fuji Spray® gravity spray gun while you are in-between coats. This gun holder also fits other standard-size center-mounted gravity feed spray guns.

PLEASE NOTE: This is not compatible with the 9600-G and the 7002G spray gun. It is also not compatible with other side-mounted spray guns.



#5375 MAGNETIC SPRAY GUN HOLDER

Use this device to hold your gravity feed spray gun. Portable and can be attached securely to any metal surface including workstations, spray booths and body shop walls.

Heavy duty magnet supports up to 10 lbs.



#4009-2 DIY-PRO™ SERIES & PREVIOUS MODELS MINI-MITE TURBINE FILTER

These turbine filters fit the Semi-PRO 2™, Hobby-PRO 2™, and previous Mini-Mite™ model turbines.

- Dual filtration
- Quick-change friction fit filters
- Fine filters on the left-hand side (as seen when looking at front of the case), coarse filter on right-hand side

PLEASE NOTE: These filters will not fit the Super model or PLATINUM models.



#7224-2 FILTERS FOR MINI-MITE PLATINUM™ ONLY

These turbine filters fit the Mini-Mite PLATINUM™ turbines only and are available in a 2-pack.

- They are semi-circle shaped, rather than a square
- Dual filtration
- Quick-change friction fit filters
- High capacity open pore technology filters dust and particles while maintaining excellent airflow

PLEASE NOTE: For previous model square-shape Mini-Mite filters, please see above part #4009-2.



#5029 Q-TURBINE FILTER

- This turbine filter fits all Q-Series™ turbines
- Reticulated Polyurethane foam filter
- Quick change friction fit filters
- Porous material offering amazing breathability

Designed for optimal air ventilation, while trapping dust particles within the cell structure

PLEASE NOTE: The turbine does not have to be taken apart to remove or replace the filter. This filter is accessed through the bottom and can be replaced in seconds.



#3100 SPRAY GUN CLEANING KIT WITH LUBRICANT

This complete 19pc spray gun cleaning & maintenance kit with lubricant is designed for all types of spray guns. It includes an extra-long 12" pick-up tube brush, body cavity brush, detail end brush, nylon bristle parts brush, 5-pc. micro brush set, 6-pc. precision needle set, and spray gun lubricant.



#3072 WIRELESS TURBINE REMOTE

This turbine remote allows you to control the on/off switch of your turbine from a distance. No need to walk back and forth to your turbine. This device will work within a frequency range of 60 feet and can extend the lifetime of your turbine motor by reducing operating times. No setup – just plug and play! 120v only.





FUJI SPRAY® MPX-30™ MID-PRESSURE COMPRESSOR SPRAY GUN

The Fuji Spray® MPX-30™ gun has been developed to fill the gap between conventional high-pressure spray guns and HVLP. Using only medium pressure (mp) levels similar to reduced pressure (rp) spray guns, the MPX-30™ combines rapid application speed and higher transfer rates.

The MPX-30™ is a general-purpose spray gun; perfect for any type of professional spray finishing. Versatile in terms of application and performance handling, it applies all types of coatings with ease - including high solid materials.

The MPX-30™ is easy to operate, embodying the same familiar controls as any conventional high-pressure spray gun while offering many of the benefits of HVLP. The fan pattern control offers precise fan adjustment, reducing overspray and waste. The optimized air cap design results in a soft spray pattern and outstanding atomization. Faster work is ensured by the particularly wide fan and the high material flow rates.

The gun is compact, lightweight, and easy to handle. The ergonomic design allows the spray gun to feel comfortable in the hand for extended periods of time.



COMPRESSOR SPRAY GUNS

KEY FEATURES

- The fan pattern control offers precise fan adjustment reducing overspray and waste
- Produces a 13" fan pattern at a target distance of 8"
- Creates a softer, easier to control spray
- VOC Compliant
- Environmentally friendly
- Gravity feed MPX-30 spray gun is installed with 1.4mm
- Siphon feed MPX-30 spray gun is installed with 1.7mm
- Recommended 13.8cfm at 36psi

WHY MPX-30™?

- MPX-30™ technology combines rapid application and higher transfer efficiency
- 100% stainless steel fluid passages suitable for waterborne and solvent-based coatings
- Perfect for any type of professional spray finishing
- Optimized air cap design results in soft spray pattern and outstanding atomization
- Multiple air cap sets allow for spraying of various materials in different viscosity levels (stains, glazes and automotive/marine coatings)
- Fan pattern control allows for precise adjustments to reduce overspray and waste

DESIGNED FOR FULL SYSTEM APPLICATION

- Solvent-based basecoats, low VOC colors or clear coat, high solids
- Nozzle and air cap sizes available (in mm): 1.0; 1.3; 1.4; 1.7; 2.0
- Gravity Feed Gun is installed with 1.4mm
- Siphon Feed Gun is installed with 1.7mm
- MPX-30™ kits include a regulator and an extra tip

COMPRESSOR SPRAY GUNS

FUJI SPRAY® LX-20™ HVLP COMPRESSOR SPRAY GUN

The Fuji LX-20™ is a general purpose HVLP spray gun perfect for all types of professional spray finishing. It can handle with ease all types of coatings including high solid materials. This spray gun is designed for use in a production setting.

The LX-20™ spray gun has been designed to replace conventional high-pressure spray guns. It is available in gravity feed or pressure feed models. Fuji HVLP compressor spray guns are well known for higher transfer rates. Especially suited to wood finishing and any fine-finishing application.

The gun is compact and lightweight - easy to handle. The ergonomic design allows the spray gun to feel comfortable in the user's hand for extended periods of time.



KEY FEATURES

- High transfer efficiency means less overspray and increased savings
- Optimized air cap design results in soft spray pattern and outstanding atomization
- The fan pattern width ranges up to 13"
- Perfect for any type of professional spray finishing
- 100% stainless steel fluid passages suitable for water-borne and solvent-based coating
- Recommended 15.2cfm at 26psi
- VOC-compliant
- Environmentally friendly spray gun

WHY LX-20™?

- LX-20™ is designed for all types of coating including high solid materials, perfect for use in production settings
- Available in gravity feed or pressure feed models
- Especially suited to wood finishing and any fine finishing application
- LX-20™ is compact and lightweight - easy to handle. The ergonomic design allows the spray gun to feel comfortable in the user's hand for extended periods of time
- LX-20™ technology also allows for little or no dilution for most coatings

DESIGNED FOR FULL SYSTEM APPLICATION

- Fan pattern size is adjusted with a simple, yet effective side mounted control
- Precise fan adjustment reduces overspray and waste
- Nozzle and air cap sizes available (in mm): 1.0; 1.2; 1.4; 1.7; 2.0
- All LX-20™ spray guns are installed with 1.4mm
- LX-20™ spray guns kits include a regulator and 2 additional air cap set sizes (1.2 & 1.7)
- Excellent value

COMPRESSOR ACCESSORIES

#6300 SERIES MPX-30™ AIR CAP SETS

High-efficiency air cap sets for MPX-30™ compressor spray gun ONLY.

Sizes available: 1.0, 1.3, 1.4, 1.7, 2.0

Please note these parts will not fit any turbine spray guns.



#6382 MPX-30™ REBUILD KIT

Rebuild Kit for Fuji MPX-30™ Compressor Spray Gun

THIS REBUILD KIT INCLUDES:

- Air Distributor
- Needle Packing
- Needle Packing Nut
- Spindle Valve
- Valve Spring
- Fluid Screw Nut
- Needle Spring
- Fluid Control Knob

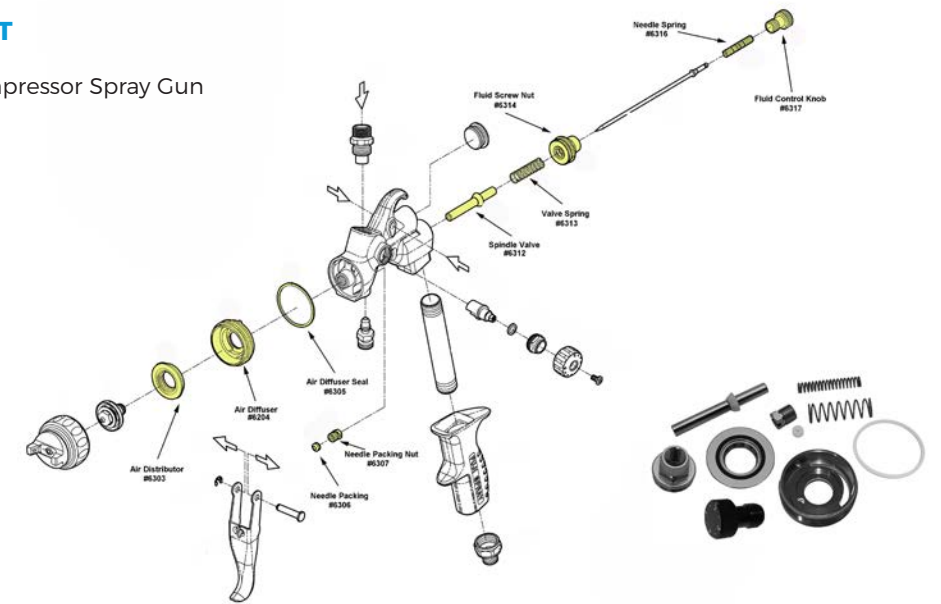

#6200 SERIES LX-20™ AIR CAP SETS

High-Efficiency air cap Sets for LX-20™ compressor spray gun ONLY.

Sizes available: 1.0, 1.2, 1.4, 1.7, 2.0

Please note these parts will not fit any turbine spray guns.



#6282 LX-20™ REBUILD KIT

Rebuild Kit for Fuji LX-20™ Compressor Spray Gun

THIS REBUILD KIT INCLUDES:

- Air Distributor
- Air Diffuser
- Air Diffuser Seal
- Needle Packing
- Needle Packing Nut
- Spindle Valve
- Valve Spring
- Needle Spring
- Fluid Screw Nut
- Fluid Control Knob

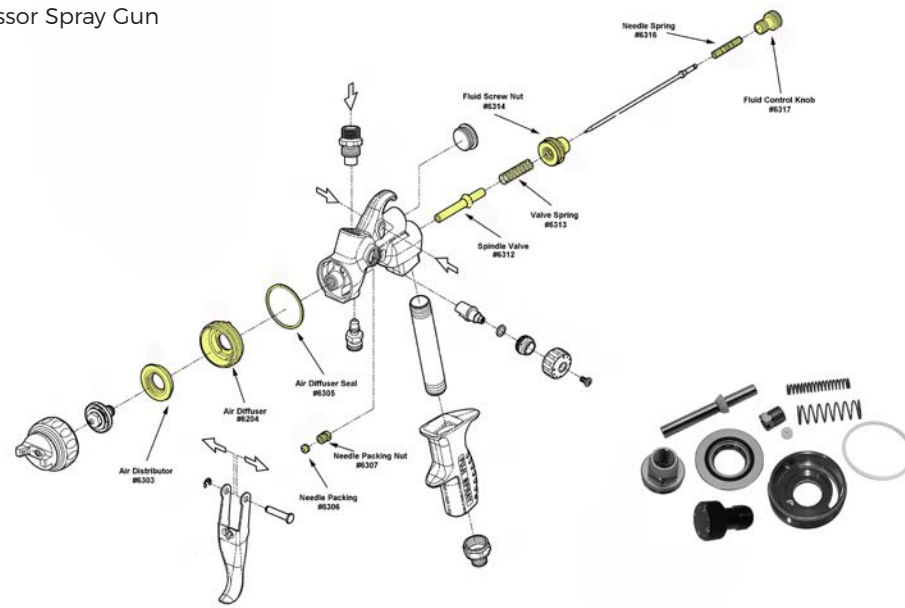

#5466 2QT. PRESSURE POT WITH 6' FLUID AND AIR HOSE

- Maximum air supply pressure 40 PSI (4.1 bar)
- Safety valve setting 40 PSI (4.1 bar)
- Air inlet size 1/4" NPS (M)
- Fluid outlet size 3/8" NPS (M)

FEATURES:

- Ability to spray at any angle, including upside down
- Twice as much material capacity than your bottom feed spray gun, and more than three times the capacity of your gravity feed spray gun

ITEMS INCLUDED:

- 2 Qt. pressure pot assembly
- 6' 2-in-1 fluid and air hose



#5470 2.5 GALLON PRESSURE POT

- Maximum air supply pressure 60 PSI (4.1 bar)
- Safety valve setting 60 PSI (4.1 bar)
- Air inlet size 1/4" NPS (M)
- Fluid outlet size 3/8" NPS (M)
- Air Distributor

FEATURES:

- Large casters for ease of transporting
- Ability to spray at any angle, including upside down

ITEMS INCLUDED:

- 2.5 gallon pressure pot assembly
- 4 casters

Recommended to purchase the 25ft 2-in-1 fluid and air hose #5487



TURBINE SPRAY GUNS AT-A-GLANCE

						
Accessories	T-70™	T-75G™	G-XPC™	M-Model (Bottom Feed)	M-Model (Gravity Feed)	Touch-up
Pressure Tubes Packs	2024-5	2024L-5	2024L-5	2026P-5	2024L-5	9629-3
400cc Gravity Cup Parts Kit		2030 (Aluminum)	2030		2030	
600cc Gravity Cup Parts Kit		2060 (Aluminum)				
1 Qt. Cup Parts Kit	2039			2039		
Gaskets - 1Qt. Cup 5pk	2036-5			2036-5		
Gaskets - 3oz (auto) 3pk		8081-3	8081-3			
Gaskets - 400cc Alum. Cup 5pk Cup 5pk		9050-5	9050-5		9050-5	
Gaskets - 600/1000cc Alum. Cup 5pk		9720-5				
Gaskets - Chemical Resistant 400cc Cup 5pk			9204C-5		9204C-5	
Gaskets - Chemical Resistant 600/1000cc Alum. Cup 5pk Cup 5pk		9216C-5				
Gaskets - White 3pk						8281ST-3
Diaphragm 3pk	2038-3			2038-3		
Pick Up Tube Strainer (Siphon) 5pk	9044-5			9044-5		
Reusable Paint Strainer 3pk	9025-3	9025-3	9025-3	9025-3	9025-3	
Cone Paint Strainers 40pk	9070-40	9070-40	9070-40	9070-40	9070-40	9070-40
Mesh Barrel Strainers (Gravity) 10pk		9030-10				
Rebuild Kit	5262	5262	9610			
1 Qt. Cup (Non-Teflon)	2041			2041		
1 Qt. Cup (Teflon)	2041T			2041T		
1 Qt. Cup Assembled Non-Teflon	2042			2042		
1 Qt. Cup Assembled Teflon	2043T			2043T		
Caps for Cups 3pk	9903-3			9903-3		
3 oz Gravity Cup		9730	8080			
400cc Alum. Gravity Cup		9740	9850			
600cc Alum. Gravity Cup		9760				
1000cc Alum. Gravity Cup		9775				
600cc Nylon Gravity Cup		9860	9870			
Gun Holder Stand - Gravity		5330				
Mini 3-Cup Set	9080			9080		
Mini Cups with Lid 6pk	9811-6			9811-6		
U-Tube Gravity Cup	9960			9960		

						
Accessories	T-70™	T-75G™	G-XPC™	M-Model (Bottom Feed)	M-Model (Gravity Feed)	Touch-up
T-Model Aircap Set (.8mm)	5100-1	5100-1				
T-Model Aircap Set (1.0mm)	5100-2	5100-2				
T-Model Aircap Set (1.3mm)	5100-3	5100-3				
T-Model Aircap Set (1.5mm)	5100-4	5100-4				
T-Model Aircap Set (1.8mm)	5100-5	5100-5				
T-Model Aircap Set (2.0mm)	5100-6	5100-6				
T-Model Aircap Set (2.5mm)	5100-7	5100-7				
XPC-Model Aircap Set (.7mm)			8050-2			
XPC-Model Aircap Set (1.0mm)			8050-3			
XPC-Model Aircap Set (1.4mm)			8050-4			
XPC-Model Aircap Set (1.8mm)			8050-5			
XPC-Model Aircap Set (2.2mm)			8050-6			
M-Model Aircap Set (.8mm)				7020-1	7020-1	
M-Model Aircap Set (1.0mm)				7020-2	7020-2	
M-Model Aircap Set (1.3mm)				7020-3	7020-3	
M-Model Aircap Set (1.5mm)				7020-4	7020-4	
M-Model Aircap Set (1.8mm)				7020-5	7020-5	
M-Model Aircap Set (2.0mm)				7020-6	7020-6	
Touch-up Spray Gun Aircap Set (1.0mm)						9624
Touch-up Spray Gun Aircap Set (1.8mm)						9625
Carrying Case for Aircap Sets	5137	5137		5137	5137	
Turbine Spray Gun Wrench	7080	7080	7076	7080	7080	
3M - #2 Adapter		MMM16003				
3M - #18 Adapter	MMM16054			MMM16054	MMM16054	
3M - #24 Adapter			MMM16110			
3M - H/O 6oz Pressure Cup	MMM16121	MMM16121	MMM16121	MMM16121	MMM16121	
3M - H/O 28oz Pressure Cup	MMM16124	MMM16124		MMM16124	MMM16124	
3M - 6oz Lids & Liners (50pk)	MMM16114	MMM16114	MMM16114	MMM16114	MMM16114	
3M - 28oz Lids & Liners (25pk)	MMM16024	MMM16024		MMM16024	MMM16024	
3M - 6oz Mix Ratio Insert (50pk)	MMM16066	MMM16066	MMM16066	MMM16066	MMM16066	
3M - 28oz Mix Ratio Insert (100 pk)	MMM16091	MMM16091		MMM16091	MMM16091	

TURBINE SPRAY GUN VISCOSITY GUIDE

This reference sheet should be used as a starting guide.
Experimentation is the best way to determine which setup works best.

AIR CAP SET INFORMATION FOR FUJI TURBINE SPRAYERS																				
PART #	MODEL	SIZE	FORD #4 RUNOUT TIME (in seconds)	OUTPUT	Fine Finishing			Automotive				Other								
					Dye / Ink	Shellac / Stain	Sanding Sealer	Clear Lacquer	Varnish	Polyurethane	Pigmented Lacquer	Clear	Base	Primer	Flake Additives	Bathub Coatings	Oil-based Primers	Oil-based Paints	Waterborne Primers	Waterborne Paints
8050-2	GXPC	0.7mm	8 or less	Fine	█	█														
7020-1	M	0.8mm																		
5100-1	T																			
8050-3	GXPC	1.0mm	8 - 17	Fine to Medium		█	█	█	█		█									
7020-2	M																			
5100-2	T																			
7020-3	M	1.3mm*	17-25	Medium		█	█	█	█		█									
5100-3	T																			
8050-4	GXPC	1.4mm*	17-31			█	█	█	█		█									
7020-4	M	1.5mm	25-37	Medium to High				█			█									
5100-4	T																			
8050-5	GXPC	1.8mm	37-50	High							█	█								
7020-5	M	1.8mm	37-50																	
5100-5	T																			
7020-6	M	2.0mm	50-80	High																
5100-6	T																			
8050-6	GXPC	2.2mm	80 or more	Extra High																
5100-7	T	2.5mm																		

* Standard Air Cap set





COMPRESSOR SPRAY GUN VISCOSITY GUIDE

AIR CAP SET SIZE	OUTPUT	VISCOSITY (#4 Ford)	VISCOSITY (#2 Zahn)	APPLICATION	MATERIALS
1.0mm	Fine	15 seconds and under	20 seconds and under	For spraying low viscosity materials. Delivers very fine atomization which makes it ideal for fine finishing and touch-ups.	Solvents, stains, inks and dyes
1.2mm <small>(Available only with LX-20)</small>	Fine to Medium	15 - 19 seconds	20 - 24 seconds	Great for most fine finishing applications and automotive applications. For low viscosity materials with little to no dilution.	Sealers, enamels, lacquers and primers, automotive base and clear coats
1.3mm <small>(Available only with MPX-30)</small>					
1.4mm <small>(Standard for LX-20 and MPX-30 Gravity)</small>	Medium	19 - 23 seconds	24 - 30 seconds	Similar to 1.3mm but requires less thinning. Ideal for medium viscosity materials in general finishing.	Sealers, enamels, lacquers, primers and urethanes
1.7mm <small>(Standard for MPX-30 Siphon)</small>	Medium to High	23 - 31 seconds	30 - 41 seconds	For heavier film buildup and larger surfaces. Applicable for medium to high viscosity materials.	Enamels, epoxies, primers and urethanes
2.0mm	High	31 seconds and higher	41 seconds and higher	Suitable for industrial grade coatings and high solid materials.	Adhesives, high solid automotive coatings, high solid enamels and heavy bodied primers

Please note: Finishing results may vary on setup depending on gun settings and model (Gravity or Siphon). Keeping record of proper setup and adjustments will promote consistent results.

COMPRESSOR SPRAY GUNS AT-A-GLANCE

NOTES

				
Accessories	MPX-30™ (Siphon)	MPX-30™ (Gravity)	LX-20™ (Pressure)	LX-20™ (Gravity)
1 Qt. Cup Assembly	6372			
1 Qt. Cup ONLY	6330			
600cc Gravity Cup Assembly		6360		6360
3oz Gravity Cup Assembly		6375		6375
Diaphragm 3pk	6332-3			
Gasket - 1Qt. Cup 5pk	6331-5			
Gasket - 3oz Cup 3pk		8081-3		8081-3
MPX Air Cap Set 1.0	6300MPX-1.0	6300MPX-1.0		
MPX Air Cap Set 1.3	6300MPX-1.3	6300MPX-1.3		
MPX Air Cap Set 1.4	6300MPX-1.4	6300MPX-1.4		
MPX Air Cap Set 1.7	6300MPX-1.7	6300MPX-1.7		
MPX Air Cap Set 2.0	6300MPX-2.0	6300MPX-2.0		
LX Air Cap Set 1.0			6200LX-1.0	6200LX-1.0
LX Air Cap Set 1.2			6200LX-1.2	6200LX-1.2
LX Air Cap Set 1.4			6200LX-1.4	6200LX-1.4
LX Air Cap Set 1.7			6200LX-1.7	6200LX-1.7
LX Air Cap Set 2.0			6200LX-2.0	6200LX-2.0
Rebuild Kit	6382	6382	6282	6282
Pressure Regulator Gauge	6380	6380	6380	6380
2Qt. Pressure Pot	5466		5466	
2.5 Gallon Pressure Pot	5470		5470	
6ft 2-in-1 Fluid and Air Hose	5486		5486	
25ft 2-in-1 Fluid and Air Hose	5487		5487	
Spray Gun Wrench	6348	6348	6348	6348
Gravity Gun Holder Stand		5330		5330
Magnetic Gravity Gun Holder Stand		5375		5375
Paper Cone Strainer 40pk	9070-40	9070-40		9070-40
Reusable Strainer 3 pk	9025-3	9025-3		9025-3
Gravity Feed Mesh Barrel Strainer 10pk		9030-10		9030-10
Caps for Cups 3pk	9903-3			
19pc Cleaning Kit	3100	3100	3100	3100

NOTES



A series of 20 horizontal blue lines spaced evenly down the page, providing a template for handwritten notes.